

## SPECIFICATIONS:

**MODEL NUMBER:** 2088-473-544

**PUMP DESIGN:** Positive Displacement 3 Chamber Diaphragm Pump

**CHECK VALVE:** (1-Way Operation) Prevents Reverse Flow

**CAM:** 3.0 Degree

**MOTOR:** Permanent Magnet, P/N 11-187-00

**VOLTAGE:** 24 VDC Nominal

**PRESSURE SWITCH:** Factory Set @ 45 PSI Shut-Off, Turn On  $25 \pm 5$  PSI  
Adjustable From 30 to 50 PSI

**LIQUID TEMPERATURE:** 130 Degrees Fahrenheit (54 Degrees Centigrade) Max.

**PRIME:** Self-Priming Up To 10 Ft. Vertical,  
Max. Inlet Pressure 30 PSI (2.1 Bar)

**PORTS:** 1/2" - 14 Male Parallel Thread

**MATERIAL OF CONSTRUCTION:**

**PLASTICS-** Polypropylene

**VALVES-** Santoprene

**DIAPHRAGM-** Santoprene

**FASTENERS-** Zinc Plated Steel

**NET WEIGHT:** 4.9 Lbs (2.22 Kg)

**DUTY CYCLE:** Intermittent (See Temp. Rise Chart)

**TYPICAL APPLICATIONS:** Industrial Transfer

## DIMENSIONS:

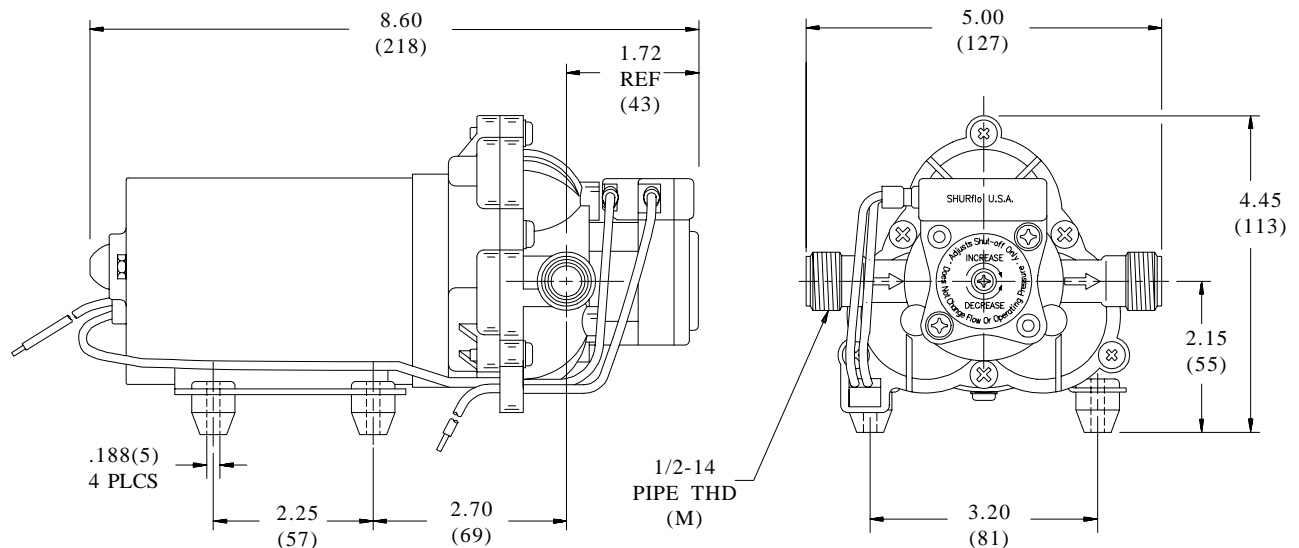

**TEMPERATURE RISE**

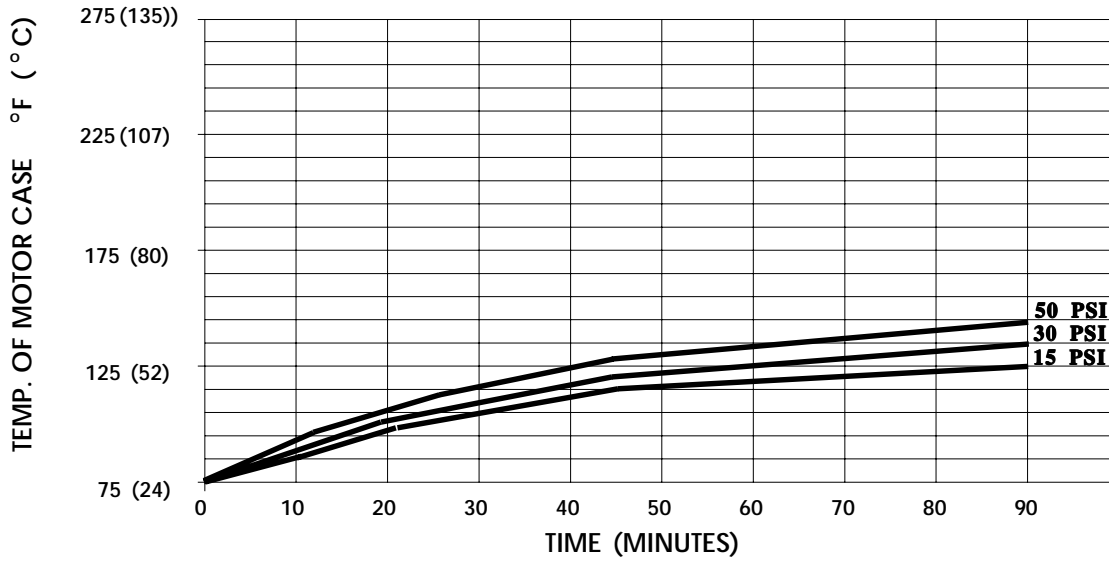

THIS GRAPH IS FOR USE AS A DESIGN GUIDE. IT IS BASED ON RUNNING CONTINUOUSLY WITH AN AMBIENT TEMPERATURE OF 75° F IN STILL AIR.

**TYPICAL PERFORMANCE**

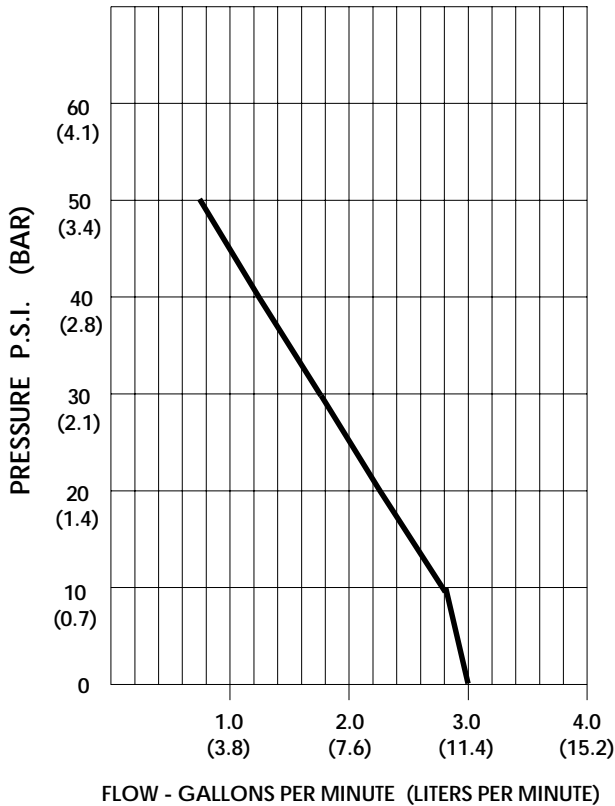

PRESSURE (PSI)	FLOW (GPM/LIT)	RPM MIN/MAX	CURRENT (AMPS)	VOLTAGE (VOLTS)
OPEN	<b>3.00/11.3</b>	<b>2218/2260</b>	<b>2.34</b>	<b>24VDC</b>
10	<b>2.80/10.6</b>	<b>2210/2250</b>	<b>2.41</b>	"
20	<b>2.25/8.5</b>	<b>2150/2195</b>	<b>2.63</b>	"
30	<b>1.75/6.6</b>	<b>2100/2140</b>	<b>2.73</b>	"
40	<b>1.25/4.7</b>	<b>2065/2100</b>	<b>2.71</b>	"
50	<b>0.75/2.8</b>	<b>2040/2070</b>	<b>2.45</b>	"

*-SPECIFICATIONS SUBJECT TO CHANGE WITHOUT NOTICE.  
-ALL DATA BASED ON TESTING WITH WATER.*